

Active helical waves produce the motion of individual waves that facilitate collective tangling and ultrafast untangling.



A tremb  
thinking  
it is the  
that are  
that belie  
physiolo  
its suffer  
its mass  
pleasure  
Glissant

In the wormhole the worm creates an infrastructure to hold itself in the world: the hole fits the worm, but only as it moves. (On the inconvenience of other people, Lauren Berlant)

Diagram of the crystallographic structure of a zinc metallo-beta-lactamase from bacillus cereus. Folding is part of the dynamics of proteins. Proteins are not strictly static objects, but rather populate ensembles of conformations. Transitions between these states occur on a variety of time scales.

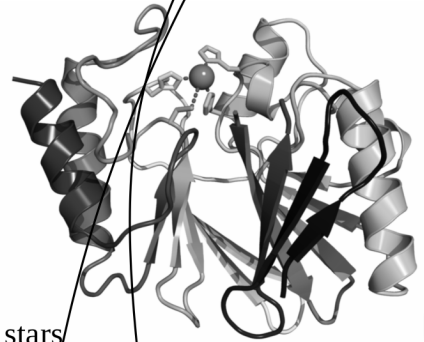

as the being together with stars

We might imagine re-turning as a multiplicity of processes, such as the kinds earthworms revel in while helping to make compost or otherwise being busy at work and at play: turning the soil over and over – ingesting and excreting it, tunnelling through it, burrowing all means of aerating the soil, allowing oxygen in, opening and breathing new life into it (Diffracting Diffraction: Cutting Together-Apart, Karen Barad)

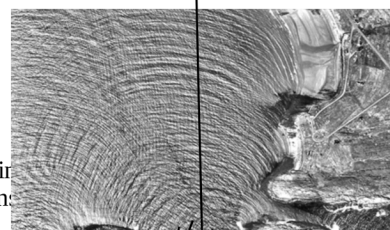
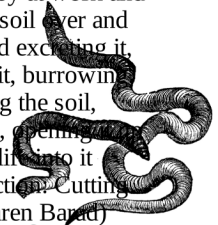

Constellations: Tracing and probable relations



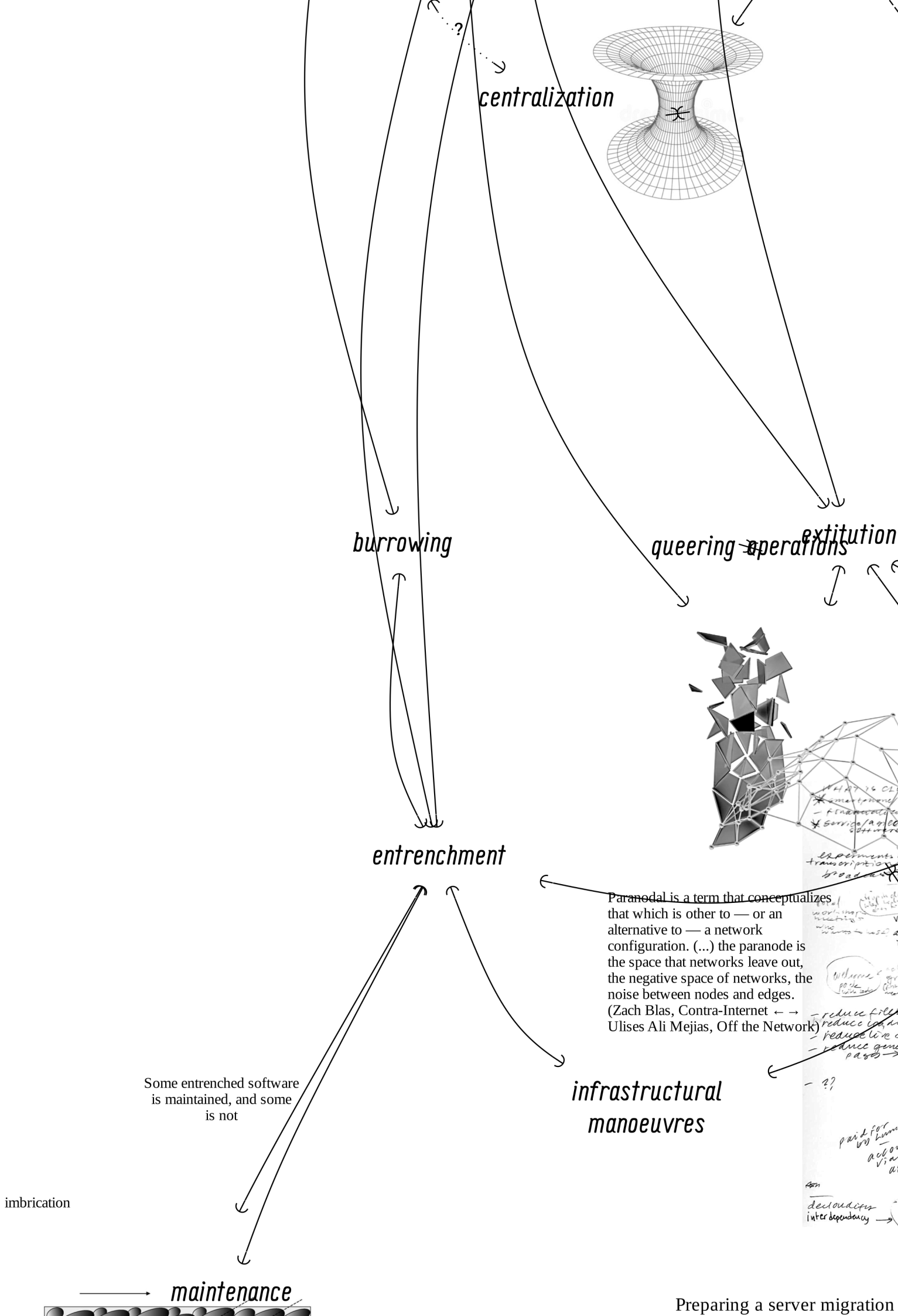

Some entrenched software is maintained, and some is not

Paranodal is a term that conceptualizes that which is other to — or an alternative to — a network configuration. (...) the paranode is the space that networks leave out, the negative space of networks, the noise between nodes and edges. (Zach Blas, Contra-Internet ↔ Ulises Ali Mejias, Off the Network)

**infrastructural manoeuvres**

imbrication

**maintenance**

Preparing a server migration

uced by  
orms  
g

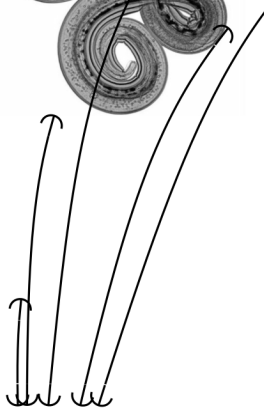

ling thought is not a frightened  
, nor a faint one,  
thought that refuses systems  
rigidly self-contained, and  
eves that the world trembles,  
ogically, in its becoming, in  
ring, in its oppositions, in  
acres, in its genocides, in its  
s. (Poetics of relation, Édouard  
)

**trembling**

**vulnerability**

**friction**

vulnerability is [not]  
reducible to its injurability.  
(Judith Butler ← → Jennifer C. Nash)

**Indeterminate  
precarity**

Indeterminacy, the unplanned nature of  
time, is frightening, but thinking  
through precarity makes it evident  
that indeterminacy also makes life  
possible. (The Mushroom at the End of  
the World: On the Possibility of Life  
in Capitalist Ruins, Anna Lowenhaupt  
Tsing)

Precarity is ambivalent, but  
are always dependent on  
from the beginning but ot  
can also harm us, so we n  
understanding of ethics to  
this ambivalence (Judith B

**seamfulness**

**affective  
infrastructur**

**Ambivalent precarity**

**nonsovereignty**

If The Commons claim sounds like an  
incontestably positive aim, I think of  
it more as a *trick*, and after a season

Precarity is a



*the cyst model*

*queer angles*

*biosys*

Effective control of the border crossings should strive for smooth flows of persons and goods. (Specific Objective 2.1: Smooth, Lawful, Safe and Secure Border Crossings, FRONTEX )

*dissolution*

Queer ligatures: inclusive, non-binary, post-binary fonts, under construction. The fonts use the Queer Unicode Initiative (QUNI) to encode their inclusive glyphs and make their use compatible. (Bye Bye Binary)

*ea xp ée*

This is a rhythm of endurance, of surging forward and withdrawing. It is not a rhythm of endless becoming nor of staying put; it is making the most of the "hinge," of knowing how to move and think through various angles while being fully aware of the constraints, the durability of those things that are "bad for us". (Improvised Lives, AbdouMaliq Simone)

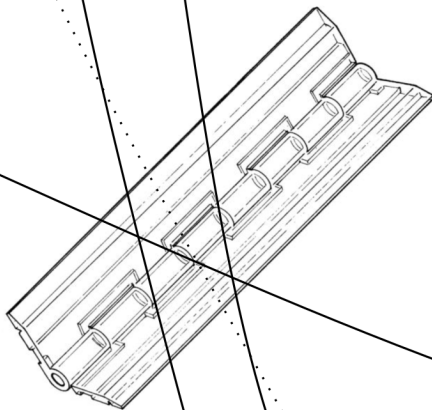
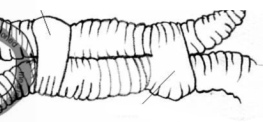

Ⓢ



vulnerability

*no borders*

Active Media Lab, supported by the National Science Foundation, the Open Society Foundations, and the European Union.

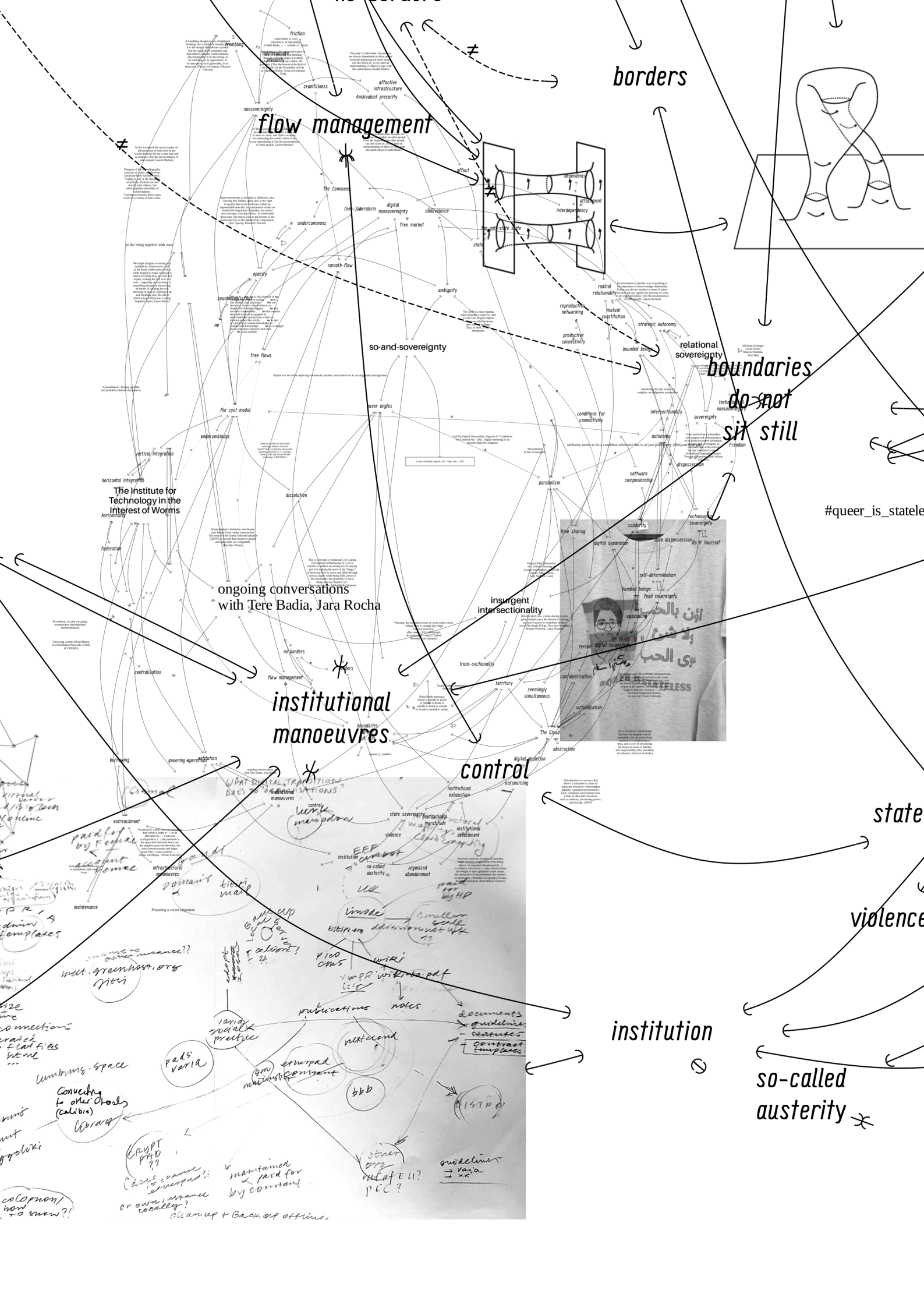

borders

flow management

boundaries do not sit still

ongoing conversations with Tere Badia, Jara Rocha

institutional manoeuvres

control

state

violence

institution

so-called austerity

The Institute for Technology in the Interest of Worms

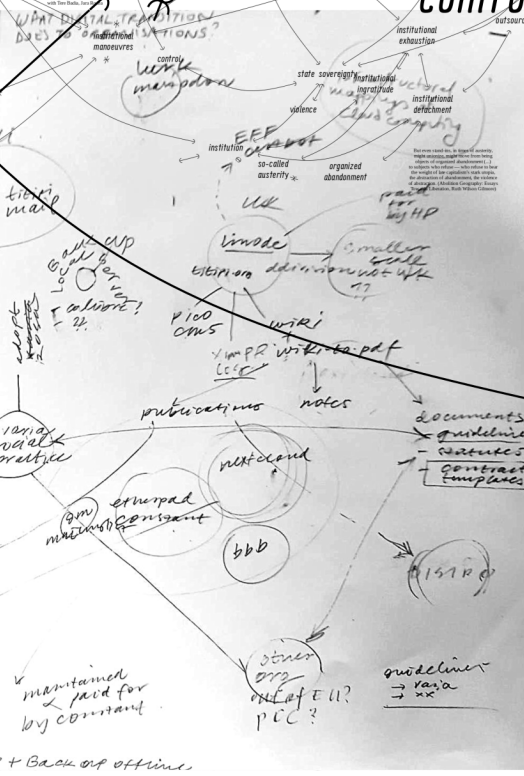

#queer\_is\_state



because we  
other people  
her people  
need an  
to cope with  
(Butler)

*e*

ambivalent, because we

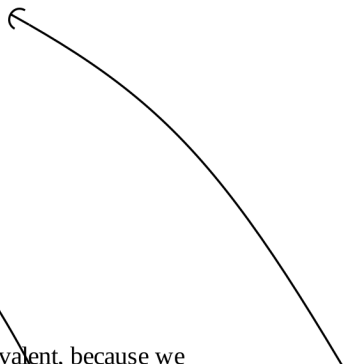



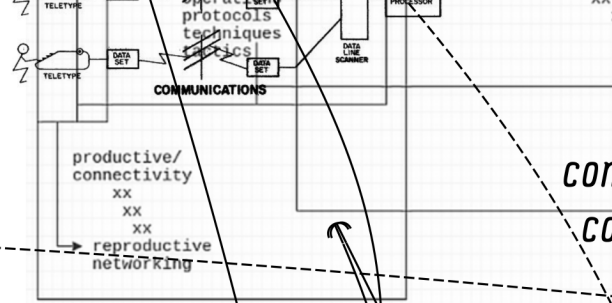

≠

Cell for Digital Discomfort, diagram of "Conditions for Connectivity," 2021, digital rendering of an abstract plain-text diagram.

The potential of less sovereignty

solidarity n

≠

So-and-sovereignty diagram, v0.5. Friday June 2, 2023

**parallelism**

**time sharing**

Teletype Plot, abstraction of a collective tracing of wormly togetherness at XPUJB (Aglaia, Bobby, Suzan, Ada, Stephen, Cara)

**insurgent intersectionality**

Warning: the bounding boxes of some nodes touch - falling back to straight line edges failed at node 0[1]  
 sfdp: maze.c:313: chkSgraph: Assertion `np->cells[1]' failed. Aborted (core dumped)

(I)n the ideal case, a time-sharing gave multiple users the illusion of exclusive access to a machine all own (The Apple II Age: How the Became Personal, Laine Nooney)



te



*trans-sectionality*

Lygia Clark, Caminhando  
[Walking] (1964)

Klein Bottle topology:  
Inside is outside is inside  
is outside is inside is  
outside is inside is outside  
is inside is outside is inside

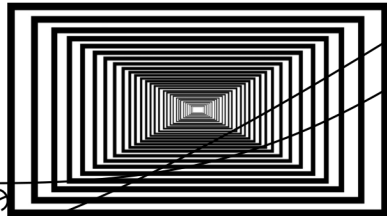

*territory*

*seemingly simultaneous*

*containerize*

*The Cloud*

*abstraction*

*digital depletion*

*outsourcing*

*institutional exhaustion*

*institutional ingratitude*

*institutional detachment*

*sovereignty*

*organized abandonment*

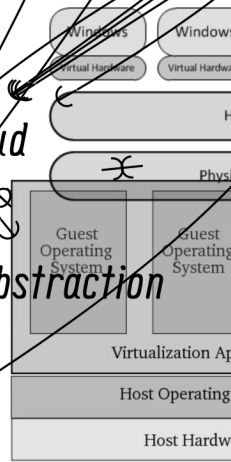

But even stand-ins, in times of austerity, might unionize, might move from being objects of organized abandonment (...) to subjects who refuse — who refuse to bear the weight of late capitalism's stark utopia, the abstraction of abandonment, the violence of abstraction. (Abolition Geography: Essays Towards Liberation, Ruth Wilson Gilmore)



cy

attachment

cy

e

y

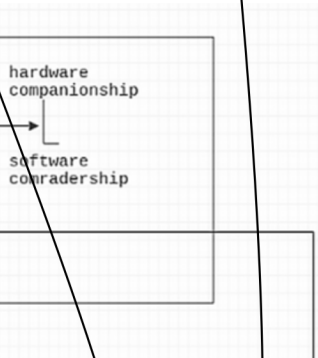

*radical  
relationality*

Inconvenience is another way of pointing to the experience of nonsovereign relationality. It does not always produce a sense of injury but does always signify the pressure of what to do with coexistence. (On the inconvenience of other people, Lauren Berlant)

⌘  
*mutual  
constitution*

*strategic autonomy*

*bounded beings*

**relational  
sovereignty**

**ACCOMPLICES  
NOT ALLIES**

Abolishing the ally industrial complex, an indigenous perspective

A colleague reports: Recently, the EU decided to use the term 'strategic autonomy' instead of 'sovereignty' because the latter term would suggest that the EU is not in support of a free market.

Miriam A  
Layal Ftou  
Maayke B  
Sruti Bala



?

authoritarian  
infrastructuring  
vs.  
defenders  
territory  
life  
inappropriate/ d  
complexity  
otherwise

conditions for  
connectivity

needs to be a condition otherwise this is all just philosophy (Miriyam Aouragh)

technological  
nonsovereignty

intersectionality

sovereignty

autonomy

Freedom  
One need not be a nationalist,  
nor imagine self-determination  
to be fixed in modern definitions  
of states and sovereignty to  
conclude that, at the end of  
the day, freedom is a place.  
(Abolition Geography: Essays  
Towards Liberation, Ruth Wilson  
Gilmore)

≠

dispossession

software  
companionship

technological  
sovereignty

solidarity

Do It Yourself

digital separation

data dispossession

≠

self-determination

bundled beings

food sovereignty?

unbundling

EX  
TELEX

system  
of having  
their  
Computer

digital sovereignty



ation

ualization

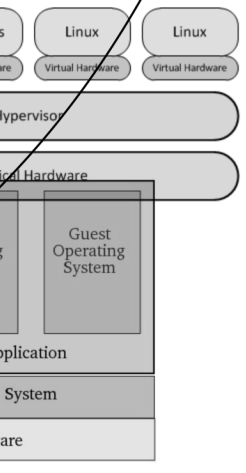

The student card, the username and password, the name.surname@institution.edu email, the LDAP credentials, the eduroam account, the Adobe license, the Zoom login, the card to pay at the canteen, the library card, the badge to enter the premises — or the recorded fingerprint directly, so you can't leave it at home

(It) is not about a relationship between the tangible and the intangible, it is about the fixed duration of a relationship of trust, and a way of structuring the future in terms of liability and responsibility (The durability of software, Erickson & Kelty)

Virtualization is a process that allows a computer to share its hardware resources with multiple digitally separated environments. Each virtualized environment runs within its allocated resources, such as memory, processing power, and storage. (AWS)